

Minimat 64 M/L

The small in-store baking oven for big baking tasks

* Maximum performance with a small footprint



THE IN-STORE BAKING OVEN

- **USE:** WIESHEU's smallest convection oven has a very small footprint. With its optional water tank it can also be moved and installed elsewhere
- **FLOW CONDITIONS:** Controllable intelligently with a right/left rotation fan for a consistent baking result
- **OPERATION:** Minimat can be operated easily and safely after only a short induction course
- **PLACE OF INSTALLATION:** The in-store baking oven is flexible when it comes to its installation. Its strength is fitting into small spaces. Its safety lock means it can also be set up in the customer area
- **PIPE STEAMING:** Fast steam generation with the correct steam quantity
- **SLIDE-IN:** The sideways slide-in ensures fast loading of 3 trays per chamber

OPTIONS

Fan wheel	With one or two fan speeds
Water supply	Tank or fixed water connection
Door	Right or left-hand hinge
Safety	Safety lock on the door when set up in the customer area
Modular construction	Capacity expansion possible at any time

COMBINATION OPTIONS

- With all Minimat 64 in-store baking ovens
- Steam reducer with fully-automatically controlled steam condenser
- Stand with pedestal
- Stainless steel prover with doors, on castors
- Storage rack

CONTROL UNITS

Manual



- On/Off Switch
- Hand steaming switch
- 2 fan speeds
- Timer switch
- Temperature setting switch
- Design: Sideways format
- Color: silver
- Temperature Range: 30 – 250 °C

Comfort



- Glass front plate with slider as touch field
- 3.2" screen diagonal
- 32 programs each with 20 steps
- Pre-programmable auto start
- °C or °F
- 2 languages and symbols
- 2 fan speeds
- Programming via USB port

TECHNICAL DETAILS

Minimat 64 M

Item Nr. X1120

Minimat 64 L

Item Nr. X1220

Number of layers of trays x tray dimensi. (mm)	3 x 600 x 400	5 x 600 x 400
Tray distance (mm)	85	80
External dimensions with pipework (W x D x H in mm)	760 x 771 x 595	760 x 771 x 745
Power requirements		
Mains	400 V 3/N/PE	400 V 3/N/PE
Frequency	50 Hz/60 Hz	50 Hz/60 Hz
Power consumption	7,7 A	11,3 A
Connected load	5,3 kW	7,8 kW
Weight (kg)/with tank	70/71,5	89,5/91
Water Pressure (kPa)	150 – 250	150 – 250

Capacity of baking product per tray (e.g. slit rolls): 15 with fresh dough, 18 with pre-baked dough pieces

TECHNICAL DRAWINGS

Front

Side

Rear

Top

Minimat 64 M

Item Nr. X1120

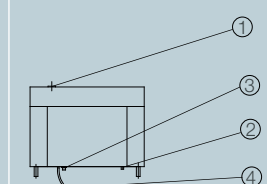
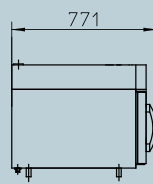
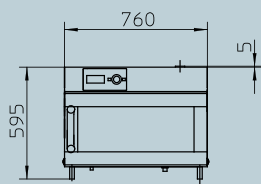

Minimat 64 L

Item Nr. X1220

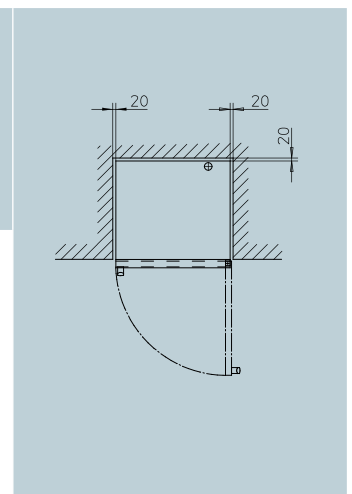
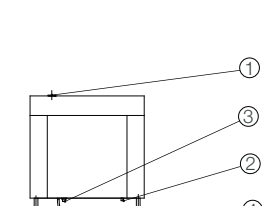
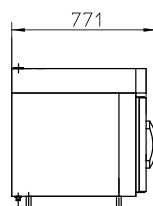
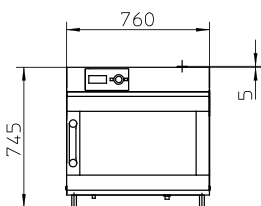

1 Outlet Air 50 mm 2 Power Connection 3 Water Connection 3/4" 4 Outflow